



ISSN: 1813-162X (Print); 2312-7589 (Online)

Tikrit Journal of Engineering Sciences

available online at: <http://www.tj-es.com>

**TJES**  
Tikrit Journal of  
Engineering Sciences

## Review of the Most Recent Work in Fault Tolerant Control of Power Plants 2018 – 2022

Waleed M. Zapar <sup>a</sup>, Khalaf S. Gaeid <sup>\*a</sup>, Hazli Bin Mokhlis <sup>b</sup>, Takialddin A. Al Smadi <sup>c</sup>

<sup>a</sup> Electrical Department, College of Engineering, Tikrit University, Tikrit, Iraq.

<sup>b</sup> Electrical Department, Engineering College, University of Malaya, Kuala Lumpur, Malaysia.

<sup>c</sup> Faculty of Engineering, Jerash University, Jordan, Member IEEE.

### Keywords:

Fault Tolerant Control (FTC); Fault Detection and Isolation (FDI); Power Plants; Stability

### ARTICLE INFO

#### Article history:

Received	14 Mar. 2023
Received in revised form	24 Apr. 2023
Accepted	18 May 2023
Final Proofreading	05 June 2023
Available online	03 July 2023

© THIS IS AN OPEN ACCESS ARTICLE UNDER THE CC BY LICENSE

<http://creativecommons.org/licenses/by/4.0/>



**Citation:** Zapar WM, Gaeid KS, Mokhlis H, Al-Smadi TA. Review of the Most Recent Articles in Fault Tolerant Control of Power Plants 2018 – 2022. *Tikrit Journal of Engineering Sciences* 2023; 30(2): 103-113.

<http://doi.org/10.25130/tjes.30.2.11>

#### \*Corresponding author:



**Khalaf S. Gaeid**

Electrical Department, Engineering College,  
Tikrit University, Tikrit, Iraq.

**Abstract:** This article covers the latest fault-tolerant control system (FTCS) developments and applications. FTCSs aim to maintain stability, minimize performance degradation, and compensate for system component faults. These systems benefit from and mission-critical applications where service continuity is crucial. This article describes several sensor and actuator errors. Fault Tolerant Control (FTC) includes active, passive, and hybrid approaches and the latest design techniques. Finally, FTCS stability and reliability analysis and research gaps were reviewed. This study provides current and future FTCS researchers with the latest trends and applications. This study's contribution. System component failures and instability are two major causes of control performance decline. Fault-tolerant control, or FTC, was developed in recent decades to improve control system resiliency. Active and passive FTC techniques exist. This paper examines control system faults, failure causes, and the latest resilience solutions. Fault detection and isolation (FDI) and active fault tolerance control (FTC) advances were examined. Encouraging FTC and FDI research, a comprehensive comparison of several aspects is performed to understand the pros and cons of various FTC techniques.

## مسح لأحدث المقالات في التحكم المتسامح مع الأعطال في محطة توليد الكهرباء 2018 – 2022

وليد م. زبار<sup>1</sup>، خلف سلوم كعيد<sup>1</sup>، هازلي مخلص<sup>2</sup>، تقي الدين الصمدي<sup>3</sup>  
<sup>1</sup> قسم الهندسة الكهربائية / كلية الهندسة / جامعة تكريت / تكريت - العراق.  
<sup>2</sup> قسم الهندسة الكهربائية / كلية الهندسة / جامعة مالايا / كوالالمبور - ماليزيا.  
<sup>3</sup> كلية الهندسة / جامعة جرش / الاردن.

### الخلاصة

تتناول هذه المقالة أحدث تطورات وتطبيقات نظام التحكم في تحمل الأخطاء (FTCS). تهدف FTCSs إلى الحفاظ على الاستقرار وتقليل تدهور الأداء والتعويض عن أعطال مكونات النظام. تستفيد من هذه النظم تطبيقات السلامة والمهام الحرجة، التي تتسم فيها استمرارية الخدمة أهميه ضرورية. توضح هذه المقالة العديد من أخطاء أجهزة الاستشعار والمشغلات. يتضمن التحكم في تحمل الأخطاء (FTC) من حيث الاساليب النشطة والسلبية والهجينة وأحدث تقنيات التصميم. وأخيراً، يجري استعراض تحليل الاستقرار والموثوقية في نظام FTCS والثغرات البحثية. تزود هذه الدراسة باحثي FTCS الحاليين والمستقبليين بأحدث الاتجاهات والتطبيقات. يعد فشل مكونات النظام وعدم استقرارها السببين الرئيسيين لتدهور أداء التحكم. تم تطوير التحكم في تحمل الأخطاء، أو FTC، في العقود الأخيرة لتحسين مرونة نظام التحكم. توجد تقنيات FTC النشطة والسلبية. وفي هذا البحث نبحث في أعطال نظام التحكم وأسباب الفشل وأحدث حلول المرونة. نقوم بفحص التقدم في الكشف عن الأخطاء وعزلها (FDI) والتحكم النشط في تحمل الأخطاء (FTC). وتجرى مقارنة شاملة لعدد من FDI و FTC لتشجيع أبحاث في الجوانب المختلفة لفهم إيجابيات وسلبيات مختلف تقنيات.

**الكلمات الدالة:** التحكم المتسامح مع الأخطاء (FTC)، اكتشاف الأعطال وعزلها (FDI)، محطة توليد الكهرباء، الاستقرار.

### 1. INTRODUCTION

When some pieces of hardware or software develop a defect, it is called a "fault" [1, 2]. A few examples of this would be a pin that has broken off in an interconnect, a faulty piece of software, or a short circuit between two adjacent interconnects. A failure occurs when an expected or required action does not occur. It is considered a system failure if, for a certain amount of time, the service it provides to the user unmatched the system specification [3]. In computing, an error is any departure from the expected result due to some sort of malfunction. Isolated micro grids (MGs) with fault tolerance via consensus-based secondary voltage and frequency restoration via sliding mode control [4]. At the power station, an industrial

establishment where electricity is produced using primary energy sources. When supplying electricity to the grid, most power plants utilize one or more generators, which convert mechanical energy into electrical energy [5]. However, solar power plants are an exception; they produce electricity using photovoltaic cells rather than a turbine. The ultimate goal of a fault-tolerant critical system (FTCS) is to keep the system stable while still providing adequate performance [6]. A fault-tolerant control system's primary goals are to keep the system performing as expected and keep the system as a whole from becoming unstable due to the presence of faults.

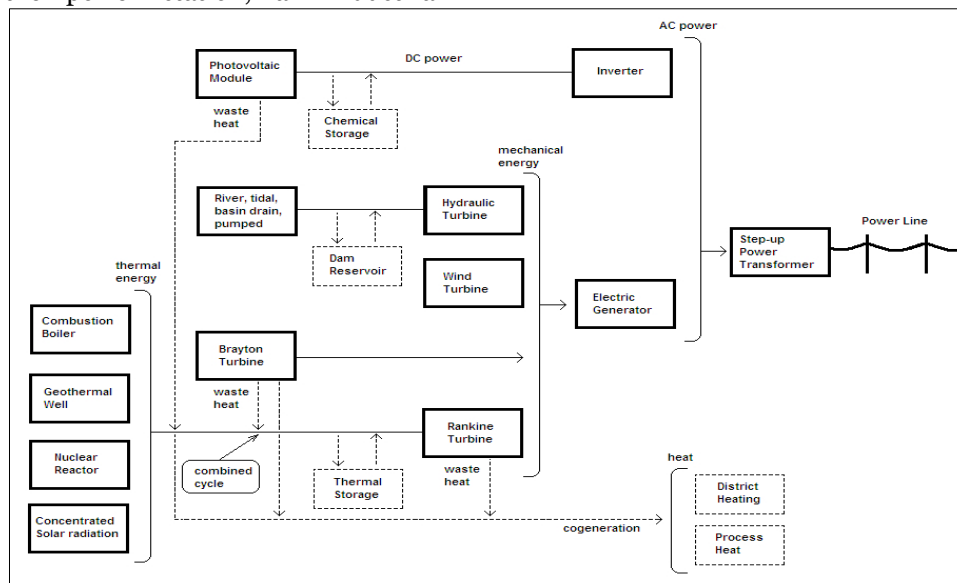

**Fig.1** Modular Block Overview of a Power Station [7].

The dashed lines in Fig. 1 represent special additions such as combined cycle and cogeneration and optional storage. Large-scale power plants and power systems are under increasing pressure to meet stringent reliability, maintainability, and survivability requirements. As a result, researchers have been hard at work perfecting fault diagnosis systems with features like detection, isolation, identification, and classification. Many FDI techniques for PPs and PSs have been developed over the last three decades, as fault detection and isolation (FDI) are essential diagnosis tasks. Simultaneously, with the advent of FDI, studies are conducted on the generation of control actions that are not overly reliant on the presence of specific faults in feedback control systems. There has been a noticeable increase in both output and quality thanks to implementing certain fault-tolerant control (FTC) strategies in PPs and PSs. This paper overviews the most up-to-date FTC and FDI techniques currently being used or developed for PPs and PSs.

## 2. FAULT-TOLERANT CONTROLLER TERMINOLOGY

The capacity of a system to continue carrying out the functions for which it was designed, even in the presence of errors, is referred to as fault tolerance. In a broader sense, fault tolerance refers to reliability linked to successful operation and the absence of breakdowns. A fault-tolerant system can continue to function properly despite malfunctions in individual parts, power outages, or other unforeseen events [8, 9]. Fig. 2 demonstrates that breaking down the two main categories into active and passive can be a part of the FTC strategies [10, 11]. To find the fault, active fault-tolerant control employs a variety of detection methods. A supervisory system will assess the situation after the fault has been located and decide how to modify best the system's control structure and parameters

[12]. When a fault occurs in a system, however, a robust compensator is used in passive fault-tolerant control to either lessen the fault's effects or stabilize the system, at the very least. In Fig. 3, it can be seen how a Micro grid would be affected by a fault and how the FTCS would work to transition through its five states, i.e., operation, fault elimination, reconnection, and fault tolerance [13- 16]. Although the terms "fault isolation" and "fault detection" are frequently used colloquially, fault isolation refers to locating and estimating the fault size, whereas fault detection only refers to the recognition of a problem [17]. The first stage in FDI design is to create an observer to gauge system output and states. Fig. 4 shows the FDI system's overall architecture. In this research, FDI methods are categorized into three broad groups based on the observer design: model-based, knowledge-based, and combined. Foreign Direct Investment is categorized in Fig 5. The earliest approach to fault diagnosis, model-based FDI dates back to 1971 [18]. Books [19, 20] and review papers [21,22] provide in-depth explorations of model-based methods. The operational system of the plant must be mathematically modeled to use model-based techniques. Physical techniques or system identification methods can be used to obtain this model. Once obtained, an observer can be developed from it to determine the system's output and look for discrepancies between by comparing the system's actual output with the expected one, the source of a malfunction can be identified. Numerous model-based techniques, including the Kalman filter [23, 24], the  $H_\infty$  [25, 26], and the observer in sliding mode (SMO) [27, 28], were employed in the observer's design. (The acronyms: SMO: Sliding Mode Observer, EKF: Extended Kalman Filter, UKF: Unscented Kalman Filter, PCA: Principal Component Analysis, ICA: Independent Component Analysis, PLS: Partial Least Square, SVM: Support Vector Machine, and ANN: Artificial Neural Networks [29].

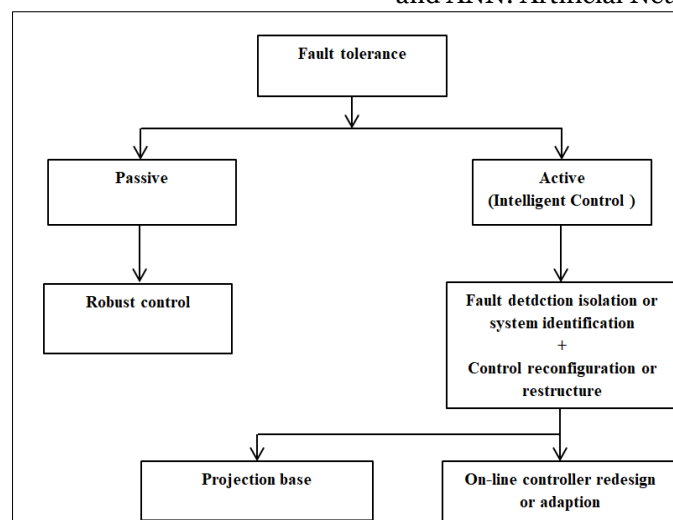

**Fig.2** Decomposition of Fault-Tolerant Control.

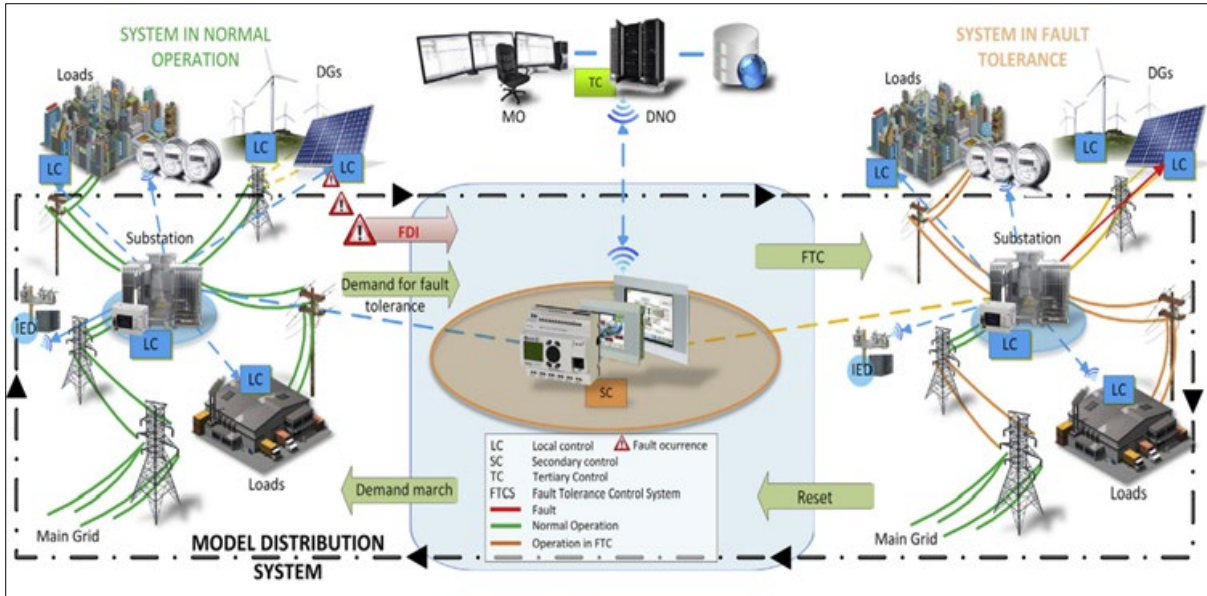

**Fig.3** Faults on the Distribution System and a Fault Tolerance Architecture [13].

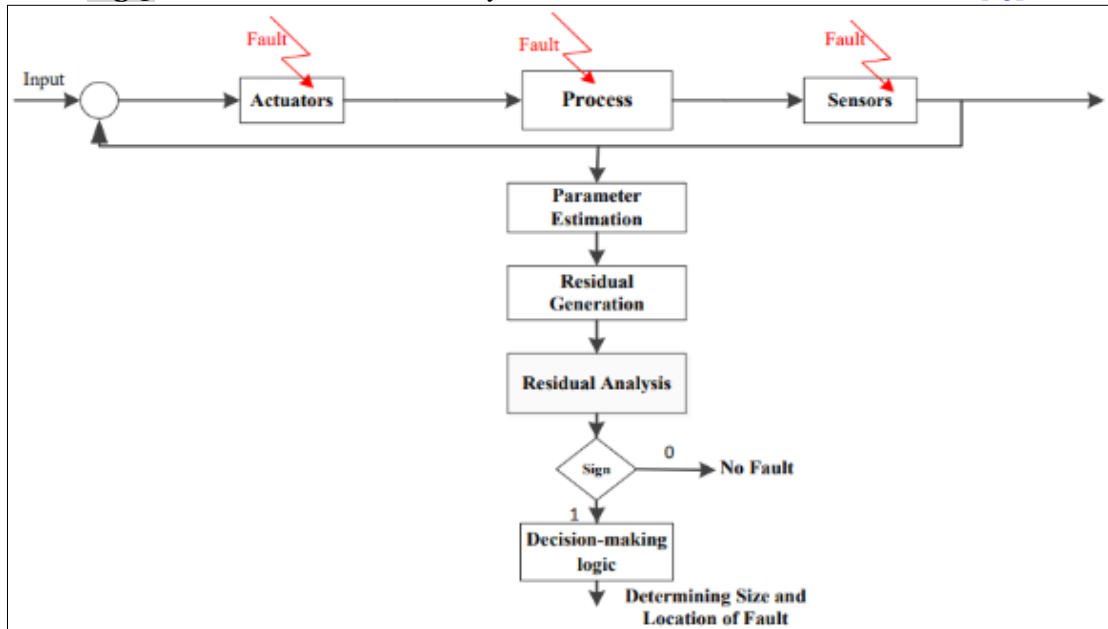

**Fig.4** General Framework for Fault Isolation and Detection (FDI) [29].

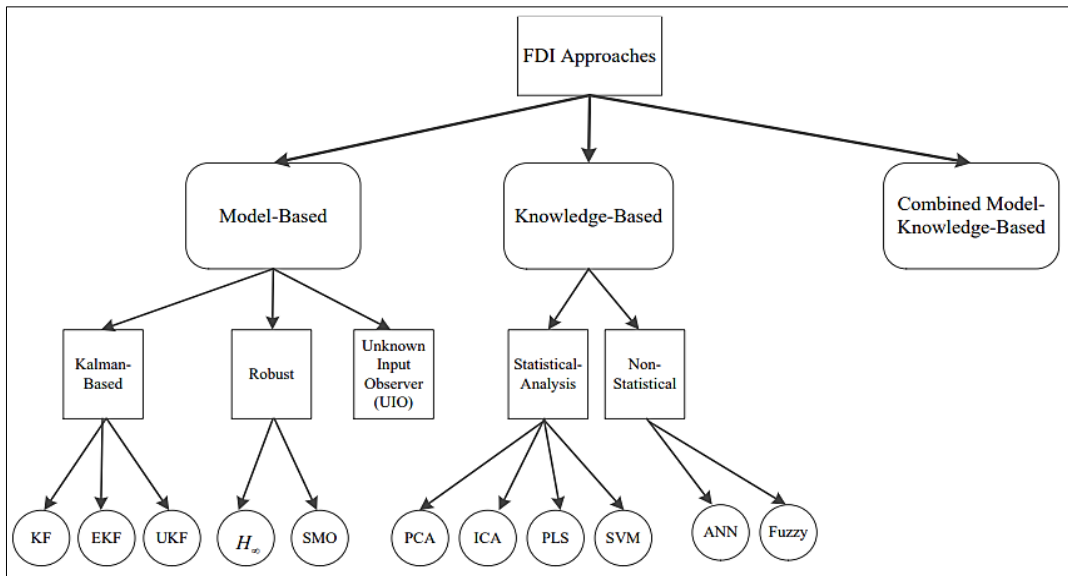

**Fig.5** Classification of FDI Methods According to their Methodology.

### 3. KNOWLEDGE-BASED APPROACHES

Knowledge-based approaches do not require but need many performance data from the past. Artificial intelligence has been used to find faults in industrial systems' historical data. Fig. 6 shows the block diagram of a knowledge-based FDI algorithm. The majority of experience and understanding of FDI methods view diagnostic issues as pattern recognition issues. Thus, statistical or non-statistical methods can solve the FDI problem. Thus, knowledge-based FDI is classified into two groups: those that use statistical analysis and those that do not.

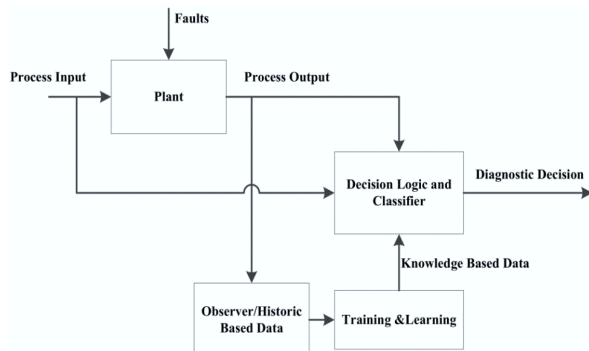

**Fig.6** The Fundamental Design of Knowledge-Based FDI Strategies [29].

### 4. COMBINED MODEL-KNOWLEDGE-BASED APPROACH

There are distinct benefits and limitations to both model-based and knowledge-based contact. In particular, model-based FDI techniques are well-suited to real-time applications because they can detect faults with a low computational burden. However, the system's mathematical model precision is contingent on detection precision. However, knowledge-based methods can be applied to complex industrial systems even if a model is unavailable or difficult to acquire because they are not reliant on the model of the system. Knowledge-based approaches need many training data even though they might be able to identify undefined fault types, experience high computational load, and have other drawbacks. It was proposed to combine these two FDI approaches to reap the benefits of each while mitigating their respective shortcomings, i.e., inaccuracy and computational burden. To develop an FDI system for satellite sensors and actuator faults, Talebi et al. integrated a recurrent ANN with a nonlinear observer [30].

### 5. ACTUATOR AND SENSOR APPROACH FOR FTC SYSTEMS

Actuators and sensors can experience faults such as offsets and stocks in control systems, reducing or losing effectiveness. These flaws can cause a decline in performance compared to the nominal, fault-free system or, in the worst case, cause the system to become unstable. By preserving stability conditions and keeping the system's performance close to the desired one,

Fault Tolerant Control (FTC) can operate reliably even when errors occur [31]. Numerous factors determine a control system's ability to accommodate a failure, including the type of failure, the robustness of the characterized theory, and the existence of mechanisms that add redundancy to actuators or/and sensors. Literature generally divides techniques into two categories, i.e., active and passive, based on the degree of control they provide (see [32] for a review). Passive FTC methods use control laws that factor in the occurrence of faults as a perturbation to the system. Therefore, the system can tolerate the presence of faults because the control technique also has built-in fault tolerance capabilities of faults within certain margins. However, active FTC methods modify the control law based on data from the Fault Detection and Isolation (FDI) module [31]. This data is used to make post-fault-appearance automatic adjustments to the control loop in an effort to meet the control objectives with as little impact on performance as possible. Most FTC techniques are designed for LTI (Linear Time Invariant) systems. In contrast, Linear Parameter Varying (LPV) systems have gained popularity in recent years due to the potential to employ such a strategy when utilizing nonlinear systems. The LPV methods are a subset of the broader category of gain-scheduling methods, which have proven to be a powerful solution to nonlinear systems' analysis and synthesis challenges. Shamma [33] introduced the LPV systems concept to differentiate between Linear Time-Invariant (LTI) and Linear Time-Varying (LTV) [34]. The LPV paradigm has since become a common formalism in systems and control, used for analysis, controller synthesis, and even system identification. The LPV paradigm can be used to schedule gains in nonlinear systems. The nonlinearity is built into the changing parameters that depend on some endogenous signals, like some system states. In this situation, the system is called "quasi-LPV" to set it apart from "pure LPV" systems, where the only thing that changes the parameters are the external signals. Even though the LPV theory was originally used to design controllers for perfect systems, it is now also used to fix broken systems. Actuator faults in nonlinear systems may be discovered and recognized using LPV models and a Kalman filter, which estimates the amplified states that are also intimately connected to the faults, as reported in [35]. To deal with the simultaneous failure of multiple actuators in polytypic LPV systems, [36] developed a FTC strategy focused on Static Output Feedback (SOF). In Ref. [37], Fig. 7 shows similar strategies.

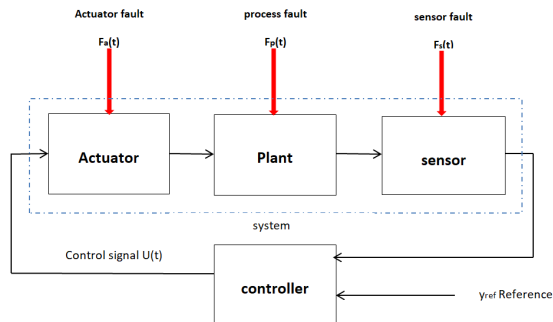

**Fig.7** Actuator/Sensor FTC Scheme [37].

## 6. TYPES OF POWER STATIONS AND THE EFFECT OF FAULT TOLERANCE ON THEIR PERFORMANCE

When it comes to fault tolerance, it is important for power stations to be designed with redundancies and backup systems to ensure continuous operation in the event of a failure, which involves redundant equipment, backup power sources, and automated systems for monitoring and responding to faults. A power station with high fault tolerance can continue operating despite equipment failure or other issues, ensuring reliable and continuous electricity generation. However, increasing fault tolerance can also increase the complexity and cost of the power station, so it is important to balance these factors when designing and operating power stations.

### 6.1. Thermal

Mechanical power is generated in thermal power plants via a heat engine that converts thermal energy, typically from fuel combustion, into rotary energy. Because steam is a byproduct of nearly all thermal power plants, the two terms are sometimes used interchangeably. Thermal power plants that generate electricity by burning fossil fuels like coal or natural gas are called fossil fuel power stations. The stations that rely on fossil fuels have machinery that can transfer the thermal energy released during combustion into mechanical energy, which can then be used to power a generator. The prime mover has a few options, including steam turbines, gas turbines, and reciprocating gas engines in smaller plants. Each of these plants derives its power from expanding a hot gas, usually steam or combustion gases. There are many ways to convert energy; however, all of them at thermal power stations are limited by the Carnot efficiency and thus generate waste heat.

The majority of the world's demand for electrical power comes from fossil fuel power plants. While some fossil fuel power plants are built to run nonstop as baseload generators, others are better suited for intermittent use as peaker generators. However, with the advent of the 2010s, many nations began operating plants originally intended for baseload supply as a dispatch able generation to counteract the

growth in variable renewable energy generation [38].

### 6.2. Nuclear

A crucial part of a nuclear power plant using pressurized heavy water reactors (PHWR) and pressurized water reactors is the steam generator (SG) (PHWR). To operate SG safely in power plants, the water level must be controlled. Reactor shutdowns may be frequent due to poor liquid level control in SG. The SG control system's closed-loop performance may significantly deteriorate due to biases in the level and pressure sensors' measurements. To stop the conventional controllers' performance from degrading in the appearance of sensor bias [39, 40], this task seeks to develop a fault-tolerant control framework. As depicted in Fig. 8.

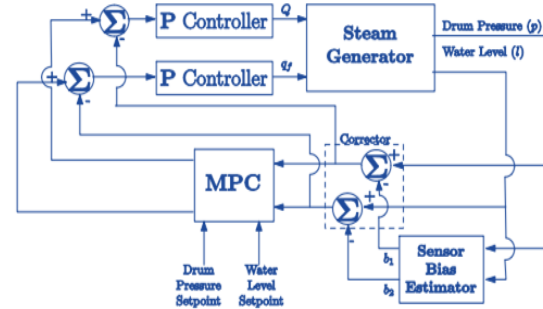

**Fig.8** Schematic of Sensor Fault Tolerant Control for SG [39].

### 6.3. Solar Thermal Power Plants

Solar-thermal power generation works by collecting solar radiation through reflectors like heat exchanger condensers and converting it into heat energy for hot charging, which heats the heating device inside the heat transfer medium, such as heat conduction oil or molten salt with a heat exchange device. Tower solar thermal power generation system features: (1) Tower solar thermal power generation systems have concentration-light ratios of 300 to 1,500 and operating temperatures of 1,000 to 1,500 °C [41]. (2) Large-scale commercial applications can use solar tower power generation. (3) The tower solar-thermal power generation system is expensive and requires a large initial investment [42]. (4) Large-scale commercial applications can use solar tower power generation. Steam from hot water powers an electricity-generating turbine. The "light-heat-mechanical-electrical energy transformation process" powers concentrated solar power technology. Fig. 9 shows that solar thermal power generation uses similar equipment to fossil fuel power plants. The main difference is power generation heat sources. Solar thermal power uses clean, abundant solar energy [43].

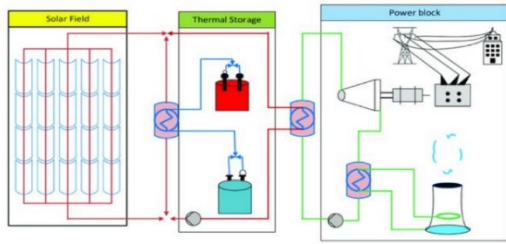

**Fig.9** Concentrating Solar Power (CSP) Plant Model with Thermal Energy Storage (TES) System [43].

**6.4. Renewable**

Renewable energy is energy collected from renewable resources naturally replenished on a human timescale. It includes sources such as sunlight, wind, water movement, and geothermal heat [44].

**6.4.1. Hydroelectric Facilities**

Electricity produced from hydropower is known as hydroelectricity or hydroelectric power (water power). In 2020, hydropower generated almost 4500 T<sub>Wh</sub> of the world's electricity, more than all other renewable energy sources combined and more than nuclear power [45]. The highest of all renewable energy technologies in 2021, installed hydropower had an electrical capacity of nearly 1400 GW [46].

**6.4.2. Wind Turbines**

Active FTC controls wind turbine rotor speed and power despite actuator faults and uncertainties. Adaptive output feedback sliding mode controllers with integral surfaces and adaptive gains are suggested. Abbas pour et al. [29] published one of the best reviews in the field of FTC in 2020 and looked into the fundamental ideas of active FTC. Fig. 10 is the introduction to the section of [47] titled "Reliability Improvement of Wind Turbine Power Generation using Model-based Fault Detection and Fault Tolerant Control: A Review."

**Table 1** Concerned with Wind Turbine Breakdowns.

Name	Description	Warning	Stop
Genover Temp	High generator temperature	Derate	Normal
Gearboxfail	High gearbox temperature	Derate	Normal
Highxaccel	High turbine fore-aft (x direction) acceleration	Stop	Normal
Freqsensorfail	Generator and HSS speed disagree (power electronics or cabling or sensor issue)	Stop	Normal
Torque Sensor Failure	HSS torque disagrees with torque command or ISS torque	Wait	Normal
Gboilpressurelow	Low gearbox oil pressure	Wait	Normal
Yawbrakeerror	Yaw drive hydraulic pump malfunction: high yaw brake Oil pressure, yawing when brake set, or yaw brake set unintentionally	Wait	Normal
Yawposerror	Nacelle vane and wind direction disagree.	Wait	Normal
Torque Overload	High HSS/LSS torque	Derate	Normal
Highangularrate	High pitch, yaw, or roll acceleration	Stop	Normal
Overspeed Normal	High HSS/LSS speed	derate	normal
Met Temp Pres Fault	MET pressure or temperature out of bounds or MET temperatures different	Wait	Normal
Rpmfail	HSS and ISS speed disagree	Stop	Open-loop
Peoverpower	Instant, 1 s average power, or 1 min average power above bounds	Derate	Emergency

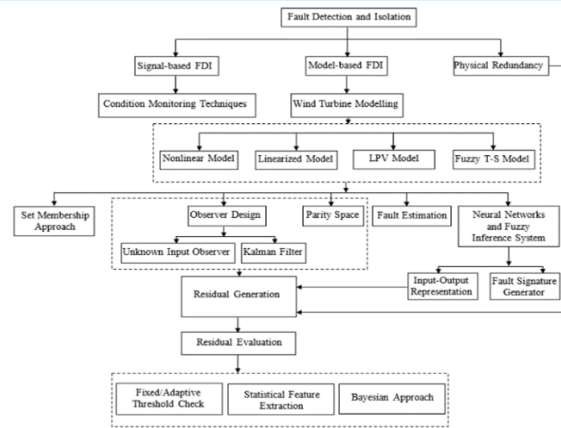

**Fig.10** FDI Methods Applied on Wind Turbines [47].

The Controls Advanced Research Turbine, with its three rotor blades, is the basis for this simulation. The whole thing over on GitHub [48] is obtained. This model allows for the simple addition of warning/fault checks, running brand-new scenarios, and replicating all previously run ones. Fig. 11 depicts a simplified model schematic.

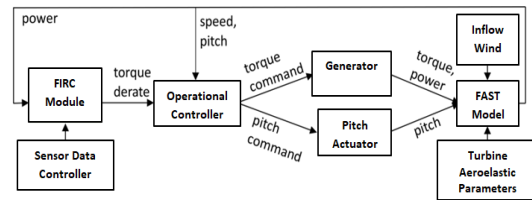

**Fig.11** Simplified CART3 Model Block Diagram.

Table 1 is from the National Renewable Energy Laboratory's (NREL) Controls Advanced Research Turbine (CART3) blade. Caution: the custom warning category we developed for this error. In the event of a malfunction, operations halt (also known as a "stop"). High-speed shaft; abbreviated HSS. Low-velocity shaft; abbreviated LSS. The study of weather and climate is known as meteorology (CART) [49].

**6.4.3. Solar Panels**

Renewable energy sources (RESs) are being used more frequently worldwide due to the negative environmental effects of fossil fuels. Due to its abundance and accessibility, solar energy, particularly photovoltaic (PV) energy, as depicted in Fig. 12, is thought to be one of the most alluring renewable energy technologies [50,51]. Between 2021 and 2026, an additional 305 GW of renewable energy capacity is anticipated to be used annually. Renewable 2021 [52] is a report by the International Energy Agency that claims to show how renewable energy can help the world. Using a fault-tolerant control system, it was analyzed how well the control strategy work when there was a fault in the connection between the three-phase, two-level power converter, and the grid. In addition, case studies comparing the CMPC performance, proportional-integral (PI), and

sliding mode control (SMC) in the presence of a grid fault were conducted [53].

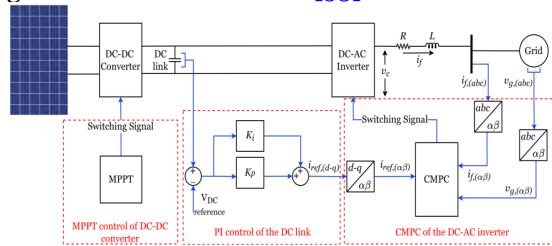

**Fig.12** PV System Topology and Control Strategy [53].

Solar PV systems have been integrated into existing power grids using a variety of topologies [54–57]. The two-stage transformerless topology is among the most widely used topologies [58]. This topology consists of a DC-DC converter and a DC-AC three-phase-two-level inverter. The converter extracts the maximum PV power and boosts the output voltage of the PV generator, while an inverter converts the DC voltage to AC voltage suitable to the power grid voltage level. Additional topologies to reduce the leakage current of a single-phase, grid-connected PV system have been presented in [59–62].

## 7. CONCLUSIONS

The fault tolerance of electric power plants can vary based on several factors, including the technology used, maintenance practices, and operational procedures. Here is a general ranking of electric power plants from highest to lowest fault tolerance:

1. Thermal power plants: fossil fuel power plants are generally reliable; however, they require regular maintenance to keep them running smoothly. They are also more susceptible to environmental factors impacting their performance over time, such as air pollution and climate change.
2. Nuclear power plants: Nuclear power plants are designed to withstand a wide range of natural and man-made disasters. They have multiple redundant safety systems, including backup power supplies, cooling systems, and containment structures to prevent the release of radioactive material in case of an accident. Additionally, they have strict safety protocols and emergency response plans in place.
3. Hydroelectric power plants: Hydroelectric power plants are generally considered reliable, with low failure rates and long lifetimes. They have few moving parts and require relatively simple maintenance. Additionally, their ability to store water in reservoirs provides some resilience against fluctuations in demand or weather conditions.
4. Wind power plants: Wind power plants are also relatively new technology and have yet to have the chance to demonstrate long-term

reliability. They depend on weather conditions and require regular maintenance to keep their blades in good condition. Additionally, they can be noisy and may pose a hazard to wildlife.

5. Solar power plants: Solar power plants are relatively new technology and have yet to have the chance to demonstrate long-term reliability. They depend on weather conditions and require regular cleaning to maintain their efficiency. Additionally, they require vast land, which can be challenging in densely populated areas.

## REFERENCES

- [1] Mondal J, Das DK. **A New Online Testing Technique for Reversible Circuits.** *IET Quantum Communication* 2022; **3**(1): 50–59.
- [2] Spatti DH, Liboni L, Flauzino RA, Bossolan RP, Vitti BC. **Expert System for an Optimized Asset Management in Electric Power Transmission Systems.** *Journal of Control, Automation and Electrical Systems* 2019; **30**(3): 434–440.
- [3] Alsuwian T, Iqbal MS, Amin AA, Qadir MB, Almasabi S, Jalalah M. **A Comparative Study of Design of Active Fault-Tolerant Control System for Air-Fuel Ratio Control of Internal Combustion Engine using Particle Swarm Optimization, Genetic Algorithm, and Nonlinear Regression-Based Observer Model.** *Applied Sciences* 2022; **12**(15): 7841.
- [4] Shahab MA, Mozafari B, Soleymani S, Dehkordi NM, Shourkaei HM, Guerrero JM. **Distributed Consensus-Based Fault Tolerant Control of Islanded Microgrids.** *IEEE Transactions on Smart Grid* 2020; **11**(1): 37–47.
- [5] Handam A, Al-Smadi T. **Multivariate Analysis of Efficiency of Energy Complexes Based on Renewable Energy Sources in the System Power Supply of Autonomous Consumer.** *International Journal of Advanced and Applied Sciences* 2022; **9**(5): 109–118.
- [6] Amin AA, Hasan KM. **A Review of Fault Tolerant Control Systems: Advancements and Applications.** *Measurement* 2019; **143**: 58–68.
- [7] Takiaddin AS, Al-Agha OI, Alsmadi KA. **Overview of Model Free Adaptive (MFA) Control Technology.** *IAES International Journal of Artificial Intelligence (IJ-AI)* 2018; **7**(4): 165–169.
- [8] Riaz U, Amin AA, Tayyeb M. **Design of Active Fault-Tolerant Control System for Air-Fuel Ratio Control of Internal Combustion Engines using Fuzzy**



- Logic Controller.** *Science Progress* 2022; **105**(2): 003685042210947.
- [9] Alsuwian T, Amin AA, Maqsood MT, Qadir MB, Almasabi S, Jalalah M. **Advanced Fault-Tolerant Anti-Surge Control System of Centrifugal Compressors for Sensor and Actuator Faults.** *Sensors* 2022; **22**: 3864.
- [10] Smadi TAA. **Computer Application using Low Cost Smart Sensor.** *International Journal of Computer Aided Engineering and Technology* 2012; **4**(6): 567-579.
- [11] Tabbache B, Rizoug N, Benbouzid MEH, Kheloui AA. **Control Reconfiguration Strategy for Post-Sensor FTC in Induction Motor-Based EVs.** *IEEE Transactions on Vehicular Technology* 2013; **62**: 965-971.
- [12] Gaeid KS, Homod RZ, Mashhadany YA, Smadi TA, Ahmed MS, Abbas AE. **Describing Function Approach with PID Controller to Reduce Nonlinear Action.** *International Journal of Electrical and Electronics Research* 2022; **10**(4): 976-983.
- [13] Ortiz L, González JW, Gutierrez LB, Llanes-Santiago O. **A Review on Control and Fault-Tolerant Control Systems of AC/DC Microgrids.** *Heliyon* 2020; **6**(8): e04799.
- [14] Ortiz L, Orizondo R, Águila A, González JW, López GJ, Isaac I. **Hybrid AC/DC Microgrid Test System Simulation: Grid-Connected Mode.** *Heliyon* 2019; **5**(12): e02862.
- [15] Afshari A, Karrari M, Baghaee HR, Gharehpetian GB, Karrari S. **Cooperative Fault-Tolerant Control of Microgrids under Switching Communication Topology.** *IEEE Transactions on Smart Grid* 2019; **11**: 1866-1879.
- [16] Al-Husban Y, Al-Ghriybah M, Handam A, Al-Smadi T, Al-Awadi R. **Residential Solar Energy Storage System: State of the Art, Recent Applications, Trends, and Development.** *Journal of Southwest Jiaotong University* 2022; **57**(5): 750-769.
- [17] Suwatthikul J. **Fault Detection and Diagnosis for in-Vehicle Networks.** *Fault Detection* 2010: 283-306.
- [18] Al-Smadi TA, Ibrahim YK. **Design of Speed Independent Ripple Carry Adder.** *Journal of Applied Sciences* 2007; **7**(6): 848-854.
- [19] Isermann R. **Fault-Tolerant Components and Control.** In: *Fault-Diagnosis Systems.* Springer, Berlin, Heidelberg; 2006.
- [20] Ding SX. **Model-Based Fault Diagnosis Techniques: Design Schemes, Algorithms, and Tools.** Springer Science & Business Media, 2008.
- [21] Venkatasubramanian V, Rengaswamy R, Kavuri SN, Yin K. **A Review of Process Fault Detection and Diagnosis: Part III: Process History Based Methods.** *Computers and Chemical Engineering* 2003; **27**(3):327-346.
- [22] Zhong M, Xue T, Ding SX. **A Survey on Model-Based Fault Diagnosis for Linear Discrete Time-Varying Systems.** *Neurocomputing* 2018; **306**: 51-60.
- [23] Manandhar K, Cao X, Hu F, Liu Y. **Detection of Faults and Attacks Including False Data Injection Attack in Smart Grid using Kalman Filter.** *IEEE Transactions on Control of Network Systems* 2014; **1**(4): 370-379.
- [24] Rahimi A, Kumar KD, Alighanbari H. **Enhanced Adaptive Unscented Kalman Filter for Reaction Wheels.** *IEEE Transactions on Aerospace and Electronic Systems* 2015; **51**(2):1568-1575.
- [25] Zhong M, Liu S, Zhao H. **Krein Space-Based  $H_\infty$  Fault Estimation for Linear Discrete Time-Varying Systems.** *Acta Automatica Sinica* 2008; **34**(12):1529-1533.
- [26] Zhang C, Zhao H, Li T. **Krein Space-Based  $H_\infty$  Adaptive Smoother Design for a Class of Lipschitz Nonlinear Discrete-Time Systems.** *Applied Mathematics and Computation* 2016; **287**:134-148.
- [27] Zhang K, Jiang B, Yan XG, Mao Z. **Sliding Mode Observer Based Incipient Sensor Fault Detection with Application to High-Speed Railway Traction Device.** *ISA Transactions* 2016; **63**:49-59.
- [28] Castillo I, Edgar TF, Fern'andez BR. **Robust Model-Based Fault Detection and Isolation for Nonlinear Processes using Sliding Modes.** *International Journal of Robust and Nonlinear Control* 2012; **22**(1):89-104.
- [29] Abbaspour A, Mokhtari S, Sargolzaei A, Yen KK. **A Survey on Active Fault-Tolerant Control Systems.** *Electronics* 2020; **9**(9): 1513.
- [30] Talebi HA, Khorasani K, Tafazoli S. **A Recurrent Neural-Networkbased Sensor and Actuator Fault Detection and Isolation for Nonlinear Systems with Application to the Satellite's Attitude Control Subsystem.** *IEEE Transactions on Neural Networks* 2009; **20**(1):45-60.
- [31] Blanke M, Kinnaert M, Lunze J, Staroswiecki M, Schröder J. **Diagnosis**

- and Fault-Tolerant Control.** *Diagnosis and Fault-Tolerant Control* 2006; **2**: 1-32.
- [32] Zhang Y, Jiang J, **Bibliographical Review on Reconfigurable Fault-Tolerant Control Systems.** *Annual Reviews in Control* 2008; **32**(2) :229–252.
- [33] Shamma JS. Analysis and design of gain scheduled control systems, Ph.D. thesis, Massachusetts Institute of Technology, Department of Mechanical Engineering, USA, 1988.
- [34] Shamma JS. An overview of LPV systems, in: J. Mohammadpour, C. Scherer (Eds.), *Control of linear parameter varying systems with applications*, Springer, 2012, pp. 3–26.
- [35] Hallouzi R, Verdult V, Babuska R, Verhaegen M. **Fault Detection and Identification of Actuator Faults using Linear Parameter Varying Models.** *IFAC Proceedings Volumes* 2005; **38**(1): 119-124.
- [36] Al-Smadi TA. **Low Cost Smart Sensor Design.** *American Journal of Engineering and Applied Sciences* 2011; **4**(1): 162–168.
- [37] De-Oca S, Puig V, Witczak M, Dziekan L. **Fault-Tolerant Control Strategy for Actuator Faults using LPV Techniques: Application to a Two Degree of Freedom Helicopter.** *International Journal of Applied Mathematics and Computer Science* 2012; **22**(1) :161–171.
- [38] Getting Wind and Sun onto the Grid. International Energy Agency. Archived (PDF) from the original on 16 December 2018. Retrieved 9 May 2019.
- [39] Rangegowda, Pavanraj & Patwardhan, Sachin & Mukhopadhyay, Siddhartha. **Fault Tolerant Control of a Nuclear Steam Generator in the Presence of Sensor Biases.** *6th International Conference on Advances in Control and Optimization of Dynamical Systems February 16-19, 2020, IIT Madras, Chennai, India.*
- [40] Buzhinsky I, Pakonnen A. **Model-Checking Detailed Fault-Tolerant Nuclear Power Plant Safety Functions.** 2019; 7: 162139-162156.
- [41] Gao S, Hou HJ. **Solar Thermal Power System Analysis.** *Water Conservancy and Electric Power Machinery* 2009; **31**(01):70-74.
- [42] Xin PY. **Comprehensive Evaluation and Application Prospect of Solar Power Generation Technology,** 5-21. *Beijing: North China Electric Power University* 2015: 5-21.
- [43] Praveen RP, Abdul-Baseer M, Awan AB, Zubair M. **Performance Analysis and Optimization of a Parabolic Trough Solar Power Plant in the Middle East Region.** *Energies* 2018; **11**(4): 741.
- [44] Ellabban O, Abu-Rub H, Blaabjerg F. **Renewable Energy Resources: Current Status, Future Prospects and their Enabling Technology.** *Renewable and Sustainable Energy Reviews* 2014; **39**: 748-764.
- [45] Hydropower Special Market Report – Analysis. IEA. Retrieved 2022-01-30.
- [46] IEA (2022), *Renewables 2022*, IEA, Paris <https://www.iea.org/reports/renewables-2022>, License: CC BY 4.0.
- [47] Habibi H, Howard I, Simani S. **Reliability Improvement of Wind Turbine Power Generation using Model-Based Fault Detection and Fault Tolerant Control: A Review.** *Renewable Energy* 2019; **135**: 877-896.
- [48] Gaeid K, Zapar WM, Maher RA, Salih AL, Qasim MA. **Digitally Controlled Bridgeless Totem-Pole Power Factor Corrector.** *Tikrit Journal of Engineering Sciences* 2022; **29**(3): 91–101.
- [49] Anderson, B., & Baring-Gould, E. (2022). **Demonstration of a Fault Impact Reduction Control Module for Wind Turbines.** *Wind Energy Science* 2022; **7**(4): 1753-1769.
- [50] Hoseinzadeh S, Garcia DA. **Numerical Analysis of Thermal, Fluid, and Electrical Performance of a Photovoltaic Thermal Collector at New Micro-Channels Geometry.** *Journal of Energy Resources Technology* 2022; **144**: 062105.
- [51] Wali SA, Muhammed AA. **Power Sharing and Frequency Control in Inverter-based Microgrids.** *Tikrit Journal of Engineering Sciences* 2022; **29**(3): 70–81.
- [52] IEA (2021) *Renewables 2021*, IEA, Paris. Available from: <https://www.iea.org/reports/renewables-2021>.
- [53] Babqi AJ, Althobaiti A, Alkhamash HI, Ibeas A. **Current Model Predictive Fault-Tolerant Control for Grid-Connected Photovoltaic System.** *AIMS Energy* 2022; **10**(2): 273-291.
- [54] Hoseinzadeh S, Garcia DA. **Numerical Analysis of Thermal, Fluid, and Electrical Performance of a Photovoltaic Thermal Collector at New Micro-Channels Geometry.** *Journal of Energy Resources Technology* 2022; **144**(6): 062105.
- [55] Hoseinzadeh S, Sohani A, Samiezadeh S, Kariman H, Ghasemi MH. **Using Computational Fluid Dynamics for**

- Different Alternatives Water Flow Path in a Thermal Photovoltaic (PVT) System.** *International Journal of Numerical Methods for Heat & Fluid Flow*. 2021; **31**: 1618–1637.
- [56] Sohani A, Dehnavi A, Sayyaadi H, Hoseinzadeh S, Goodarzi E, Garcia DA, Groppi D. **The Real-Time Dynamic Multi-Objective Optimization of a Building Integrated Photovoltaic Thermal (BIPV/T) System Enhanced by Phase Change Materials.** *Journal of Energy Storage* 2022; **46**: 103777.
- [57] Khodayar-Sahebi H, Hoseinzadeh S, Ghadamian H, Ghasemi MH, Esmailion F, Garcia DA. **Techno-Economic Analysis and New Design of a Photovoltaic Power Plant by a Direct Radiation Amplification System.** *Sustainability* 2021; **13**(20): 11493.
- [58] Zeb K, Nazir MS, Ahmad I, Uddin W, Kim HJ. **Control of Transformerless Inverter-Based Two-Stage Gridconnected Photovoltaic System using Adaptive-PI and Adaptive Sliding Mode Controllers.** *Energies* 2021; **14**(9):2546.
- [59] Janardhan G, Surendra-Babu NNV, Srinivas GN. **Single Phase Transformerless Inverter for Grid Connected Photovoltaic System with Reduced Leakage Current.** *Electrical Engineering and Electromechanics* 2022; (5):36-40.
- [60] Albalawi H, Zaid S. **An H5 Transformerless Inverter for Grid Connected PV Systems with Improved Utilization Factor and a Simple Maximum Power Point Algorithm.** *Energies* 2018; **11**(11): 2912.
- [61] Hassaine L, Bengourina MR. **Design and Digital Implementation of Power Control Strategy for Grid Connected Photovoltaic Inverter.** *International Journal of Power Electronics and Drive Systems* 2019; **10**(3):1564-1574.
- [62] Khan MNH, Forouzesh M, Siwakoti YP, Li L, Kerekes T, Blaabjerg F. **Transformerless Inverter Topologies for Single-Phase Photovoltaic Systems: A Comparative Review.** *IEEE Journal of Emerging and Selected Topics in Power Electronics* 2020; **8**(1) 805-835.