

Multivariate analysis of efficiency of energy complexes based on renewable energy sources in the system power supply of autonomous consumer



Ahmed Handam ^{1,*}, Takiyaldin Al Smadi ²

¹Renewable Energy Engineering Department, Faculty of Engineering, Amman Arab University Jordan, Amman, Jordan

²College of Engineering, Jerash University, Jerash, Jordan

ARTICLE INFO

Article history:

Received 29 November 2021

Received in revised form

23 February 2022

Accepted 4 March 2022

Keywords:

Energy complexes

Hydrogen energy

Wind energy

Autonomous consumer

Renewable energy

ABSTRACT

The aim of this study is a multivariate analysis of energy pools based on renewable energy sources in the energy supply system for the independent consumer. The research provides the mathematical formula for optimizing the main parameters and processes of the energy complex (EC) on the basis of renewable energy sources (RES) to supply energy to many independent rural consumers in the Hashemite Kingdom of Jordan. Methodology and computation models can take into account additional conditions and constraints, data, which give flexibility and versatility to the computation models. The use of methods and guidelines at the design stage will increase the competitiveness and cost-effectiveness of the Jordanian government based on reliance on alternative energy sources, and improve the overall cost to independent consumers of low energy in rural areas. The article is devoted to the solution of the problem of developing technical solutions for multivariate analysis efficiency of energy complexes based on renewable energy sources in the system power supply of autonomous consumers. However, current global trends are such that the cost of electrolyzes and fuel elements decrease, and their reliability increases. To study the economic efficiency of the application of the hydrogen accumulation system, two models were included in the calculation program. In the first of the model, the increase in diesel fuel prices corresponded to inflation, in the second, the increase in diesel prices fuel outstripped inflation by 5-10% per year. Paying attention to the first option showed that to use the system accumulation of hydrogen is not economically feasible.

© 2022 The Authors. Published by IASE. This is an open access article under the CC BY-NC-ND license (<http://creativecommons.org/licenses/by-nc-nd/4.0/>).

1. Introduction

The world's interest in renewable energy is attributed to several reasons. Firstly, many industrial countries suffer from high levels of pollution, which push the people to stand strongly against building new conventional power plants. Therefore, the only solution to overcome this problem is to introduce renewable energy plants as a replacement for conventional ones. Secondly, several countries depend on nuclear power plants for their electrical energy needs. After several nuclear disasters occurred in Japan and Russia there was a strong public movement against such type of energy. The

result was a gradual replacement of nuclear plants with renewable energy ones. The development of science and technology, and most importantly self-awareness humanity has now reached a level when energy production is determined not only by economic feasibility but also by a number of other factors, the most significant of which are: Environmental, social and factors related to the prospect of human development and energy security. In this work increased interest in the use of renewable energy sources (RES) is obvious, even despite their higher cost compared to traditional energy sources. Renewable energy sources have significant advantages environmentally and socially, Renewable energy sources have been significantly developed in countries with a limited resource base, energy security directly depends on the supply of energy resources (primarily oil and gas) from other countries. These countries include the United States, China, Japan, the countries of the European Union, and Australia. First and quite a serious signal for

* Corresponding Author.

Email Address: a.handam@aaau.edu.jo (A. Handam)

<https://doi.org/10.21833/ijaas.2022.05.014>

Corresponding author's ORCID profile:

<https://orcid.org/0000-0001-5828-9765>

2313-626X/© 2022 The Authors. Published by IASE.

This is an open access article under the CC BY-NC-ND license

(<http://creativecommons.org/licenses/by-nc-nd/4.0/>)

such countries was the 1973 energy crisis when OPEC countries increased oil prices several times. The Hashemite Kingdom of Jordan also suffers from a lack of resources, especially from oil and gas, and depends more than 90% on imports from oil-producing countries, which puts energy security at risk (Assi et al., 2012). As the new global epidemic crisis in the fight against the COVID epidemic seeks governments to plan for a post-COVID future, the transition to renewable energy offers the potential to accelerate and create new jobs, intensify economic development and promote social justice and well-being. For Jordan, there is an urgent need to diversify the Energy mix and cost reduction with renewable energy sources for long-term social and economic life. Industrial development, without putting additional pressure on public finances, for a country with abundant renewable energy resources, the transition envisaged would improve energy security and reduce costs to consumers, as well as improve environmental conservation. Jordan's energy strategy for the decade reinforces the diversification policy with an updated target of 31% renewable power capacity by 2030. Rapid population growth is bringing the economy under immense pressure in the Hashemite Kingdom of Jordan. As a rule, gasoline or diesel engines are used to supply energy to consumers. Generators, which in the conditions of Jordan reality are not always a reliable and economically acceptable source of electrical energy. For example, the cost of electricity received from a diesel power plant (DPP) at about 1\$/kWh. In some regions, the cost of 1kWh is received from diesel power plants.

Can reach 3 dollars and more (For example, in some remote villages, especially in the northeastern and southern regions of Jordan. So high the cost of electricity and heat is linked with the need to deliver fossil fuels a considerable distance into hard-to-reach areas. In this context, the use of RES in Jordan has very big prospects of its own. These areas address various aspects of the development and evaluation of renewable and alternative energy, including the conditions and procedures for the development and linkage of projects with different standards and applications Use of renewable energy sources (Lo, 2015). World experience in the development of RES resources shows that the use of only one type of RES in power supply systems for autonomous consumers does not always allow ensuring its reliable and uninterrupted power supply due to the physical characteristics of the RES themselves (Xianguo, 2011). In this regard, as a rule, the power supply of an autonomous consumer is trying to organize by combining different types of RES in so-called energy complexes (EC). They include usually include both power plants based on renewable energy sources and diesel (gasoline) power plants (DPP, GPP), as well as various types of accumulation systems energy. In this regard, the system itself becomes extremely complicated. Design of parameters and modes of EC based on RES. In the conditions of Jordan, where market relations are not

finally established and there are many random and uncertain factors affecting the efficiency of the ECs themselves based on renewable energy sources, use highly developed information, mathematical and financial software economic justification of the projected EC. It is becoming very difficult, but very urgent. The problem of creating modern special software for substantiating projects EC based on renewable energy sources, working in power supply systems of numerous autonomous consumers in Jordan (Arkhipova, 2021; Tronchin et al., 2018; Gil et al., 2021).

Renewable energy development in Jordan was one of the first Middle East countries which have used PV solar as a promising source of renewable energy. The development of renewable energy in Jordan has gone through two routes; technical and legislative. Although Jordan is a small country in terms of energy consumption and industrial level, it could attract strong international interest for its renewable energy projects. There are several reasons for that interest. Firstly, it could develop an approach for using renewable energy in systematic form by setting a mature energy law, completing a renewable energy grid code, applying net metering and wheeling systems, exempting renewable energy equipment from all taxes, and applying other mechanisms. This has enabled all sectors in Jordan to significantly benefit from renewable energy use including commercial, industrial, and residential customers. The second reason is the stability of the political system in Jordan compared with all neighboring countries. This stability has encouraged several renewable energy companies to invest in this technology and to consider Jordan as a center for promoting and marketing their products to the surrounding countries. This role was facilitated by the presence of a strong Jordanian engineering system able to transfer this technology to the local community and neighboring countries. Moreover, the intensive cooperation between all governmental and private organizations, interested in the energy industry, was significant in developing this new type of generation and its associated technology (Duchaud et al., 2019; Elistratov and Kudryasheva, 2019). The third reason for the successful application of renewable energy in Jordan is the prevailing moderate climate which is very suitable for the optimum operation of renewable energy systems in general and Photovoltaic (PV) in particular. The annual moderate average temperature and the strong direct solar radiation in Jordan are important conditions for optimum operation of PV systems. These features have attracted all manufacturers to measure the performance of their PV products and to test them to take true feedback on their new equipment and systems.

2. Literature survey

The development of the EC optimization problem based on renewable energy modern universal software and information complex designed to select

and justification of the optimal structure, the main energy parameters, and operating modes of EC, working in power supply systems (electricity and heat) of decentralized consumers of electricity in Jordan: autonomous

Low-power consumers (up to 100kW) and local power systems with a capacity of several hundred kilowatts or several megawatts. This is a huge number of civil and special consumers destinations in the North, Far East, South, and all mountainous regions of Jordan, the power supply of which is carried out mainly from gasoline (low-power) and diesel power plants (sometimes with a capacity of hundreds of kilowatts). They consume millions of tons of scarce and constantly rising cost of fossil on-renewable fuel; the emissions of its combustion residues have a negative impact on the environment. In each country, in each region, the most promising type of renewable energy sources with large potential resources in a given territory, suitable for unlimited use, are usually chosen for energy complexes (Arkhipova, 2021; Tronchin et al., 2018; Gil et al., 2021). The above regions of Jordan usually have significant resources of wind. In this regard, this paper considers an EC based on the use of wind power plants (WPP) in conjunction with DPP (GPP).

At the same time, it is possible to abandon fossil fuels, provided that hydrogen is used as a fuel for fuel cells or DPP. Jordan has great climatic diversity, and the weather is very cold in winter, especially in the mentioned places, so on a par with the provision of electrical energy is acutely the task of providing consumers with thermal energy and hot water supply (Elistratov and Kudryasheva, 2016; Tyagunov, 2017).

One of the most effective solutions to this problem is the use of heat pump units (HPU). They allow you to efficiently convert electrical energy into heat using low-grade heat (soil, sea, etc.). A schematic diagram of a power complex based on wind, diesel, HPP, and a hydrogen storage system is shown in Fig. 1. The main criterion for the optimal operation of the installation is the minimum of the reduced costs subject to full financing of the construction energy complex by local investors. Wherein inflation in the country and growth in value is taken into account fossil fuels for three options: pessimistic, medium, and optimistic. Construction of the energy complex is carried out with the involvement of local workers as well as installers' main energy structures show (Fig. 1).

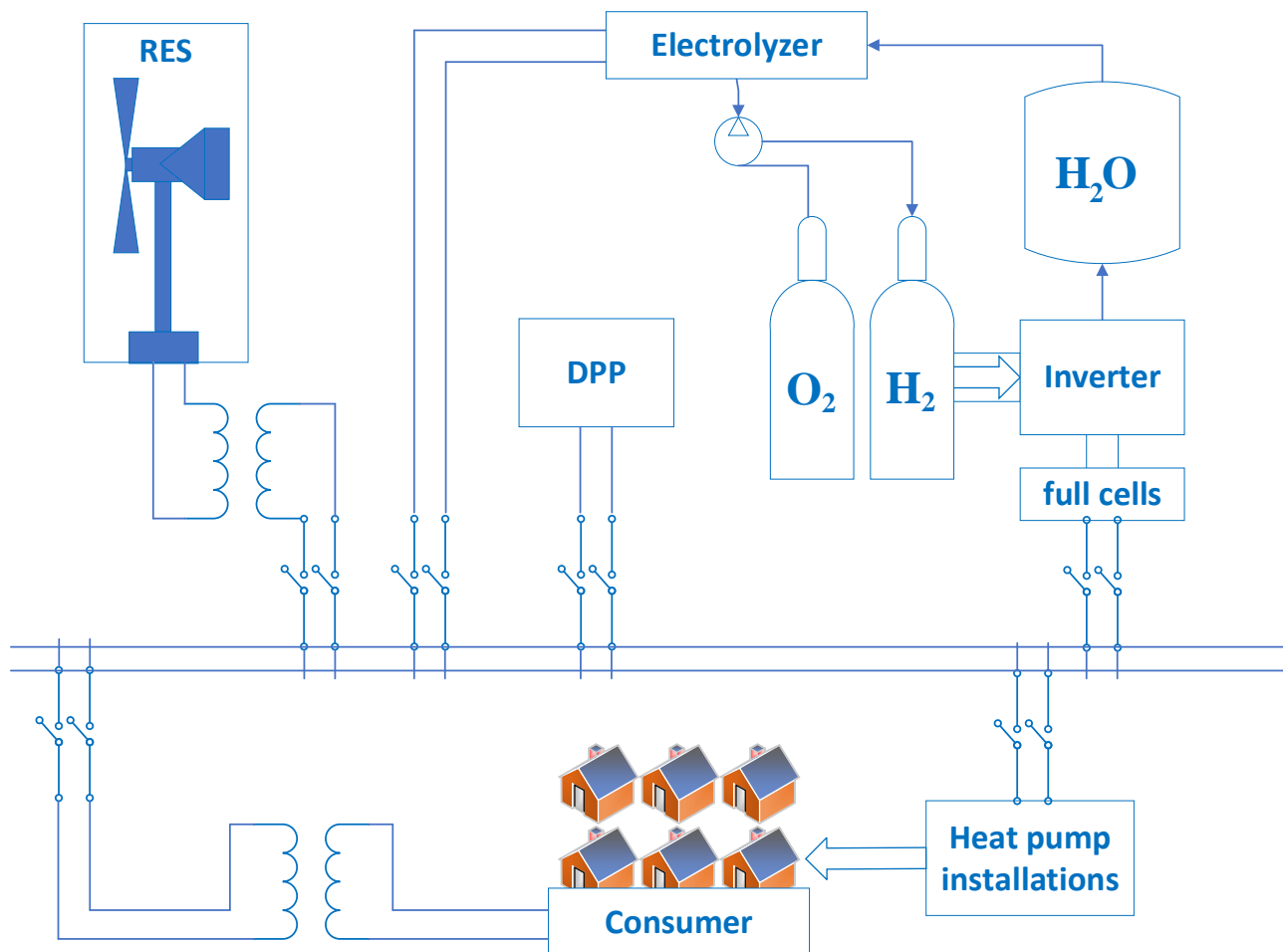

Fig. 1: Flow diagram of a power complex based on Wind, diesel, heat pump installations, and systems

The energy complex must provide reliable and uninterrupted operation of the power supply system, in the whole for this depending on the type and

category consumers in the power supply system must provide appropriate sources of energy smoothing turbulence of power output wind

turbines in time, including sources of interrupted power supply. The energy complex must provide reliable and uninterrupted operation of the power supply system on the whole. For this, depending on the type and category consumers in the power supply system must provide appropriate sources of energy smoothing turbulence of power output wind turbines in time, including sources of interrupted power supply. In this regard, for such calculations, you can use the currently existing wind speed databases. The problem under consideration is further complicated by the fact that in practice, discrete the series of capacities of all types of power plants as for based on renewable energy sources, and fossil fuels.

At the same time, an attempt to take into account all possible combinations of types of renewable energy sources and traditional types of power plants typical for power supply systems for autonomous consumers in Jordan. At the same time, analysis of territories in which are mainly located autonomous consumers shows that the most a characteristic and promising type of RES is wind energy, and the main modern source for a power supply system based on organic non-renewable fuels DPP and GPP (Min et al., 2020; Anagreh and Bataineh, 2011). Given the difficulty of delivering diesel (gasoline) fuel to remote regions of Jordan, the growth in its cost, and the negative impact of the work of DPP (GPP) on the environment, it can also be considered the need for the maximum displacement of such fuel from the power supply systems of autonomous consumers in the country is also obvious. Taking into account the above, in the general setting tasks must be known design parameters and EC modes based on renewable energy sources for power supply systems of autonomous consumers.

An autonomous consumer is considered at the design point A with its coordinates in latitude and longitude. For it, schedules of hourly consumption of heat and electric energy are set, for it, hourly consumption schedules are set. \bar{Q}_i and \bar{P}_i

$$T = t_i - t_e = \sum_{i=1}^n \Delta t_i \quad (1)$$

where $t_i - t_f$ respectively initial and final time; $\Delta t_i = 1$ h. These load curves must be covered by using wind turbines; systems for producing hydrogen H₂ and oxygen O₂, which are accumulated and are further used in fuel cells (FC) for obtaining electricity, as well as through the use of related devices: HPI, DPP or GPP. For all installations, the necessary technical and economic parameters and characteristics must be specified. For a wind turbine, its type installed power N_{WT}^{INS} , kWh, tower height H_t , m, must be indicated, power depending on wind speed $N_{WT}(v)$ cost, taking into account its delivery, installation, and operation during a given resource of the wind turbine, Permissible range of temperatures and wind speeds for the considered type of wind turbine, average hourly wind speeds V_i $i = 1, 2, \dots, n$ at point A, calculated taking into account the roughness of the terrain at point A, wind roses for

the height of the wind turbine tower (H_t) (Elistratov and Kudryasheva, 2016).

For fuel cells and systems for accumulating hydrogen and acid kind of need to know the performance of electro-Leaser, M^3/H at normal atmospheric pressure, Installed capacity P_{el}^{INS} , kWh, pressure comp Spring, the required capacity of tanks for Hydrogen storage V_{H_2} and oxygen V_{O_2} , M^3 , installed capacity Fuel cell N_{ins}^{INS} , kWh, the cost of equipment, its delivery, and installation, climatic.

Operating conditions For HPI with a vertical low-grade heat extraction system, the following should be known: Types of HPI and vertical heat exchangers, soil type (low-grade heat source), installed capacity N_{HPI}^{INS} , kWh, conversion factor power supply to heat, average daily temperatures at the design point, the cost of the HPI itself and its delivery, installation, depth, m, wells, and the cost of its drilling (Elistratov et al., 2017).

Required data on DPP (GPP): Type of DPP (GPP), specific fuel consumption SFC, l/kWh, cost fuel, the service life of DPP (GPP), and its cost.

In the calculations, the operational and energy of auxiliary equipment characteristics (inverters, transformers, measuring devices, etc.). It is required to find the optimal types and number of the main elements of the considered exploitation in order to ensure the minimum of the reduced costs for the considered settlement period of time $T = t_i - t_e$,

$$C_{\Sigma}^r(T) = C_{WT}^r + C_{fc}^r + C_{acc}^r + C_{HPI}^r + C_{DPP(GPP)}^r, \quad (2)$$

where $C_{WT}^r, C_{FC}^r, C_{ACC}^r, C_{HPI}^r, C_{DPP(GPP)}^r$ -given new costs for WT, FC, hydrogen accumulation system, HPI, DPP(GPP) accordingly, subject to the following conditions and restrictions:

$$P^{max} \leq N_{WT}^{INS} + N_{FC}^{INS} + N_{DPP(GPP)}^{INS}$$

here P^{max} -consumer peak power; $N_{WT}^{INS}, N_{FC}^{INS}, N_{DPP(GPP)}^{INS}$ -installed capacity WT, FC, DPP(GPP) respectively;

$$\bar{P}_i = \bar{N}_{WT i} + \bar{N}_{FC i} + \bar{N}_{DPP(GPP) i}, \quad (4)$$

where \bar{P}_i -average hourly power of the consumer; $\bar{N}_{WT i}, \bar{N}_{FC i}, \bar{N}_{DPP(GPP) i}$ -average hourly energy production,

$$\bar{N}_{WT i} = \bar{N}_{WT i}(V_i), \quad (5)$$

$$0 \leq V_i \leq V_{max}; \quad (6)$$

Here V_{max} -is the maximum operating wind speed;

$$0 \leq \bar{N}_{WT i} \leq \bar{N}_{WT}^{INS}; \quad (7)$$

$$0 \leq \bar{N}_{FC i} \leq \bar{N}_{FC}^{INS}; \quad (8)$$

$$N_{DPP(GPP)}^{min} \leq \bar{N}_{DPP(GPP)} \leq N_{DPP}^{INS}, \quad (9)$$

here $N_{DPP(GPP)}^{min}$ -the minimum possible power generation by DPP;

$$\bar{N}_{FCi} = \bar{N}_{FCi}(\bar{V}_{H_2}); \quad (10)$$

$$0 \leq V_{H_2}(\mathcal{N}_{FC}(t)) \leq V_{H_2}^{max} \quad (11)$$

$$V_{H_2}(T) = \int_T^0 V_{H_2}(\mathcal{N}_{WT}(t)) dt \quad (12)$$

where V_{H_2} - volume of stored hydrogen, m^3 .

In (3), one should take into account the entire main calculated Elements of the exploitation and in (2) also take into account the capital investments and other costs, recurrence of repairs, and equipment resources. Analysis of the considered problem allows us to classify it as a multifactorial, integer taking into account the constraint equations (3), conditions (6)-(11), integral constraint (12), and nonlinear constraints (five). The dependence of the reduced capital investments in exploitation on its composition can have either one extra mum or

several. To solve the problem, you need methods of the global search for a solution involving methods of mathematical programming.

To make a comparative analysis option of the considered exploitation and determine the most acceptable option, a special program was developed that allows you to compare the calculation results when changing the input parameters. Fig. 2 presents a simplified calculation algorithm composition and capital investments in the wind-diesel complex for the period T. The initial information is made up of the following data: Hourly values of wind speed; electrical and heat loads; power-graded options for wind turbines; its power depending on the wind speed v ; DPP options ranked by power; the cost of wind turbines and DPP; the cost of diesel fuel, oils.

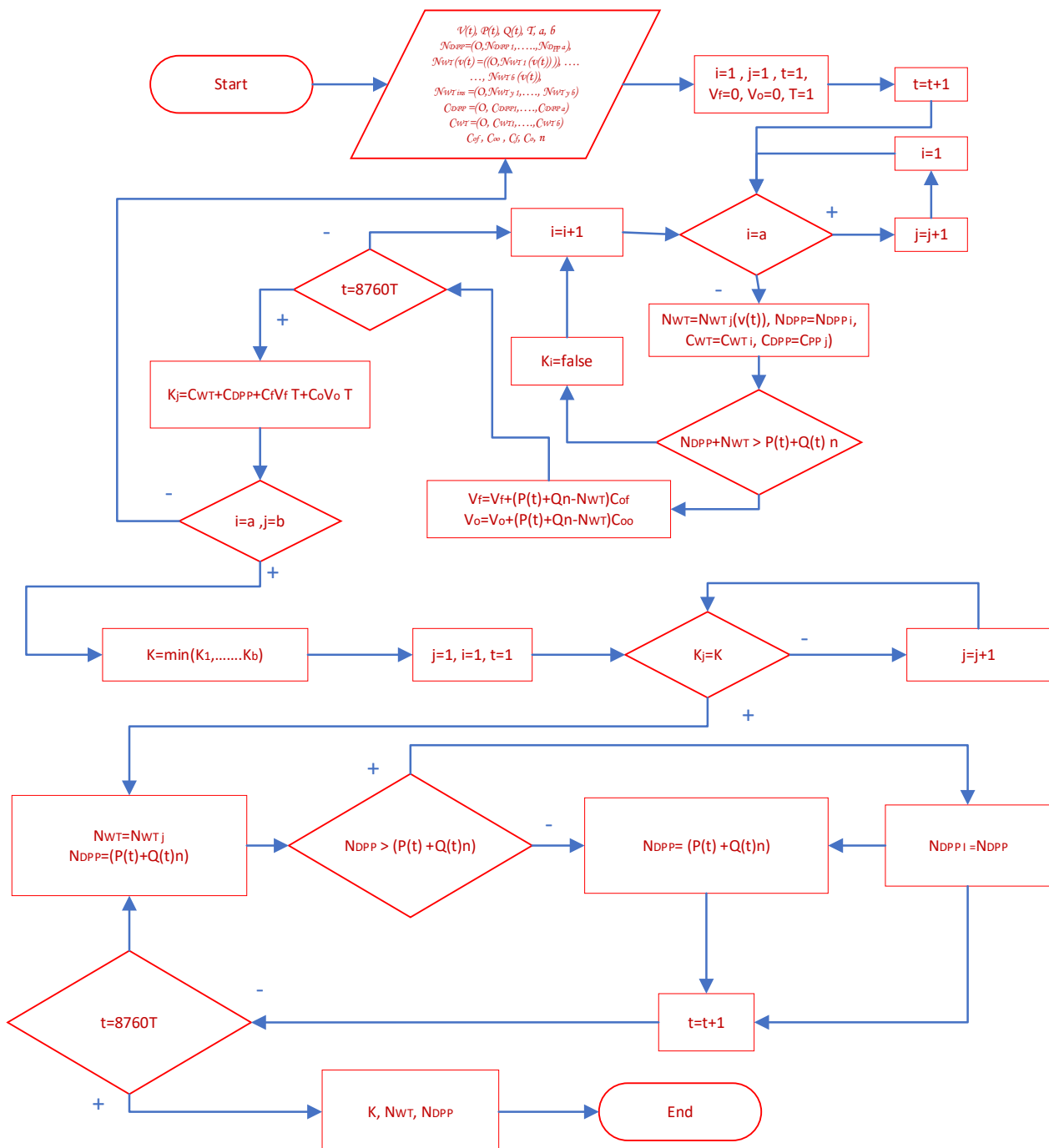

Fig. 2: Algorithm for calculating the cost of construction and operation of a wind-diesel

Complex for the power supply of an autonomous consumer for a period of time T : $v(t)$ —wind speed versus time, m/s; $P(t)$ -consumer electrical load, kW; $Q(t)$ —heat consumer load, kW; N_{DPP} -installed power of DPP, kW; $N_{WT ins}$ -installed capacity of wind turbines, kW; $N_{WT}(v(t))$ -the generated power of the wind turbine at the considered moment of time, depending on the wind speed, kW; C_{WT} -wind turbine cost, rub.; C_{DPP} -cost of DPP, rub.; C_{of} -fuel

consumption in DPP, L/kW; C_{o} -oil consumption in DPP, L/kW; C_f -fuel cost, rub.; C_o -the cost of oil, rub.; η -efficiency of the heating electric instrument; K -capital investments, rub.; a-number of wind turbine options; b-number of DPP options of the calculation of the energy complex, consisting of DPP, WT, HPI and storage systems hydrogen so (Fig. 3).

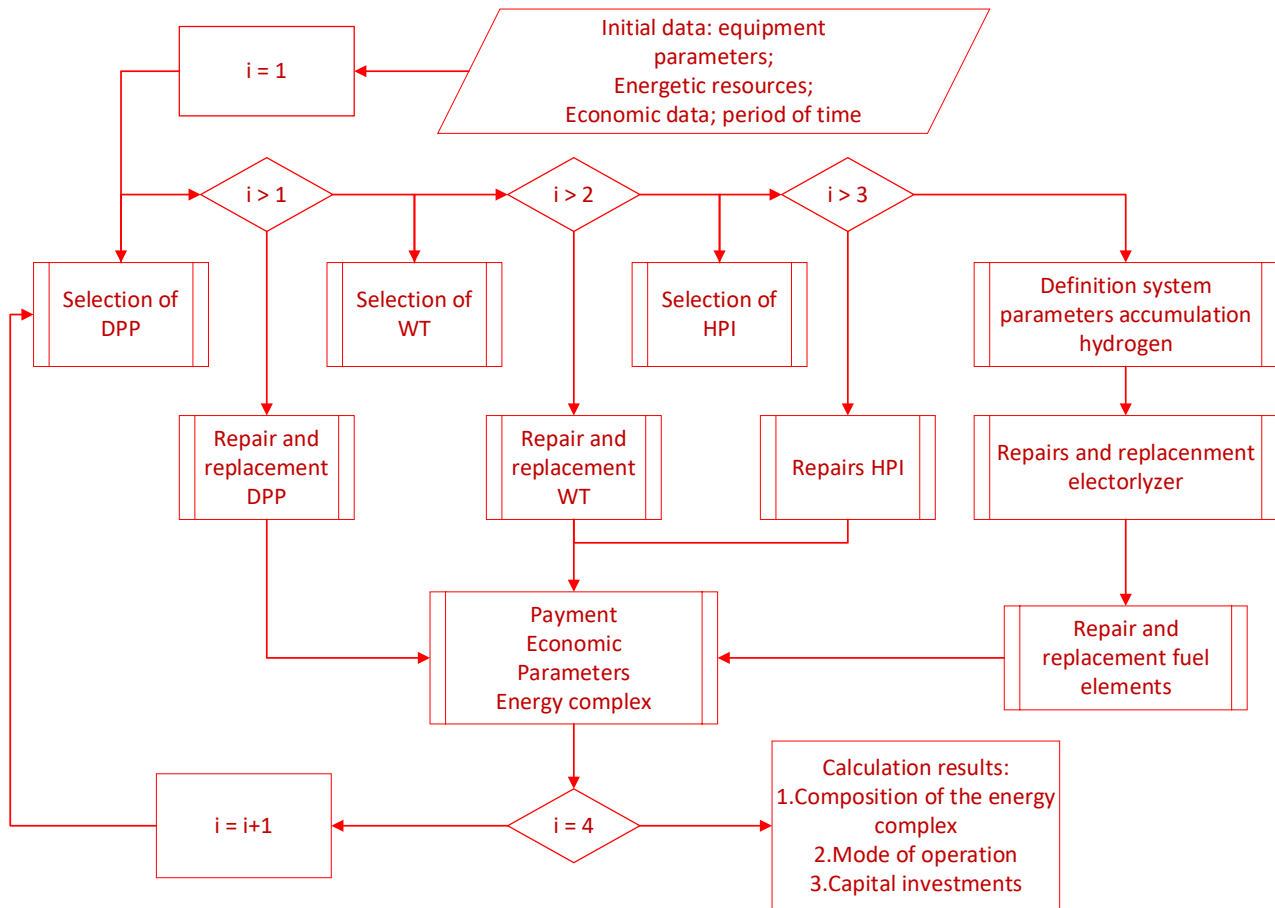

Fig. 3: Block diagram of the calculation of the energy complex, consisting of DPP, WT, HPI, and storage systems hydrogen

According to the principle of operation of this algorithm, the entire program for calculating the investigated energy complex based on VEI is built, block diagram which is shown in Fig. 3.

3. Results

The remote areas, where the price of diesel or fuel for generators and power stations is high, are many, and in the current situation, they are in dire need of independence in obtaining electricity and heating needed in the very cold winter, especially in desert areas such as Wadi Al-Hasa in southern Jordan. Wadi Al-Hasa is one of the Jordanian regions that enjoy diverse geographical terrain, and this is what makes it an important landmark for benefiting from renewable energy sources, especially wind.

As shown in Fig. 4, the average wind speed in the area is inhabited by thousands of people who need to build independent stations to generate electricity and get the necessary heating in the winter without paying huge sums to the low-income residents in the

area. Many projects can be done in this area through the study described in this paper, whether for local residents or at the commercial level, where many resorts and hotels can be built, especially since the area enjoys a diversity of terrain and a number of water springs that make it an important tourist area, in addition to having a history Important in the volatility of civilizations on their land. Assume that we need guaranteed electrical power. The supply cable is 7kw, the total max power Energy consumption under normal conditions; is 19.8kW, and if there are service Temporary employees-25.8kW. Generally, the average annual wind speed is 10m/s, which undoubtedly confirms the economic feasibility of the use of wind energy in the area. This has been shown in practice. A wind-diesel complex has been implemented at the facility on the basis of two wind turbines AWT-30, consisting of three main components: wind-driven generator set of accumulator batteries (ACB) and diesel-engine driven generator (Fig. 5). This project can serve as a good example for studying the possibility of creating

a complex, the diagram of which is shown in Fig. 1. There are delivery difficulties with diesel fuel for the facility. Installed on it wind turbines provide up to 82% of the energy needs of the consumer. The remaining 18% of electricity must be generated with the help of DPP. Applying the above-described scheme of the power complex (see Fig. 1), the use of diesel fuel can be minimized (1-2% of electricity generation), however, as studies have shown, a complete rejection of its use is currently not economically justified (Elistratov et al., 2017). One of the ways to reduce the use of diesel fuel is to use an accumulation system Hydrogen. At present, the cost of the power complex according to the diagram in Fig. 1 is high enough. In a chain electrolyze-compressor-storage system hydrogen and oxygen fuel cells include four cells in which three processes take place: Electrochemical decomposition of water

into hydrogen and oxygen; compression (liquefaction) of gases for storage; electrochemical oxidation of hydrogen for receiving electricity. A large number of elements negatively affect the reliability of the system on the whole. However, current global trends are such that the cost of electrolyzers and fuel Elements decrease, and their reliability increases.

To study the economic efficiency of the application of the hydrogen accumulation system, two models were included in the calculation program. In the first of the model, the increase in diesel fuel prices corresponded to inflation, in the second-the increase in diesel prices fuel outstripped inflation by 5-10% per year. Paying attention to the first option showed that using the system accumulation of hydrogen is not economically feasible.

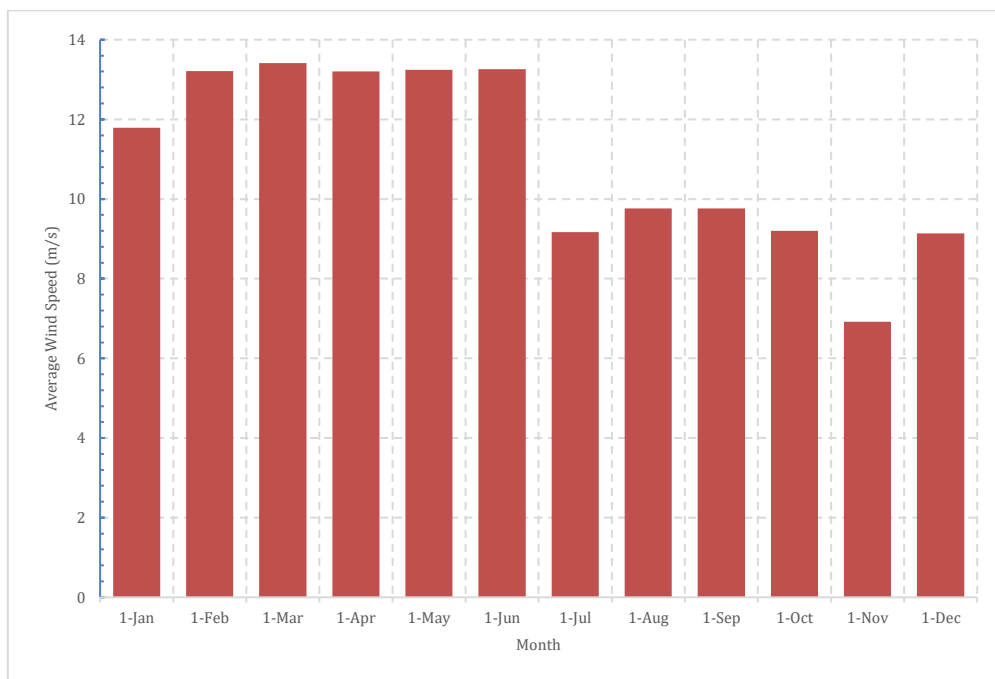

Fig. 4: Monthly average values of wind speeds in Wadi al Hasa, Jordan

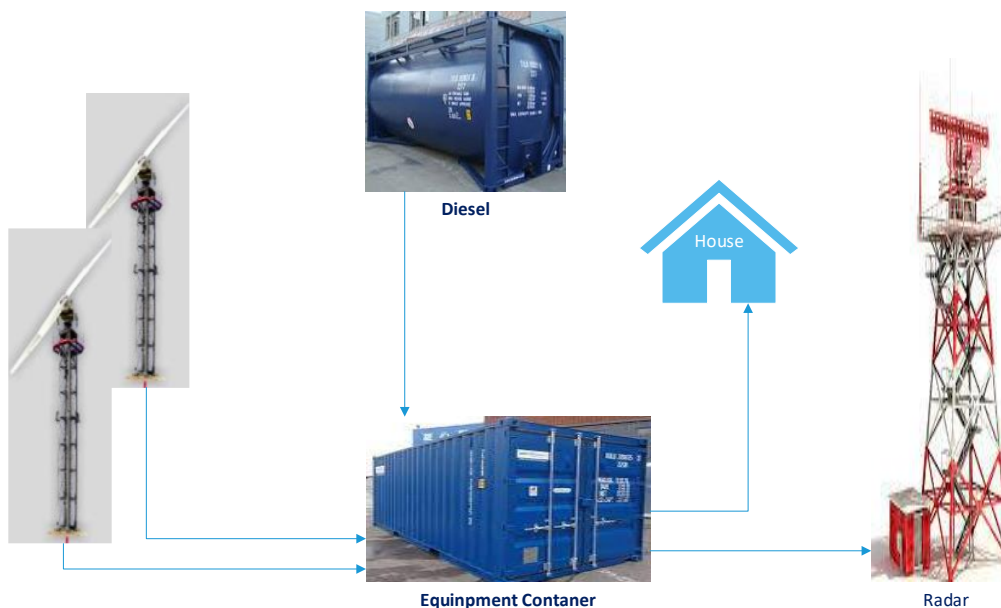

Fig. 5: Autonomous wind-diesel complex with a capacity of 60kW

The calculation of the second option showed that the use of hydrogen technologies can be sufficiently effective. The most preferable turned out to be a power complex with the following parameters: Installed capacity of wind turbines-40kW; electrolyze power-10kW; hydrogen storage capacity -1000m³. Power of fuel cells-10kW. The cost of such a power complex will be 176 326 united states dollars, and the payback period will not exceed 9 years. Considering that there are already two wind turbines with a capacity of 30kW each, then the installed capacity of the electrolyze will be 6kW, fuel cells-12kW; capacity of hydrogen storage-1500m³, and the payback period will exceed 10 years. Fig. 6 shows a graph illustrating the operation of the

investigated power complex and the dependence of power on time. During the period when the wind speed allows the wind turbine to operate at the optimum mode, the generated power is sufficient for the power supply of the consumer, as well as for the production of hydrogen (zone 2 in Fig. 6). As soon as the wind speed decreases, and therefore decreases power generation, missing capacity is replenished by the previously accumulated hydrogen (zones 1 and 3 in Fig. 6). With full use of hydrogen or system failure, the DPP is turned on (zone 4) in Fig. 6. The work is not explicitly reflected in HPI, however, the electrical power consumed by it is included in the load schedule. Since the system uses hydrogen storage, hydrogen must be stored somewhere.

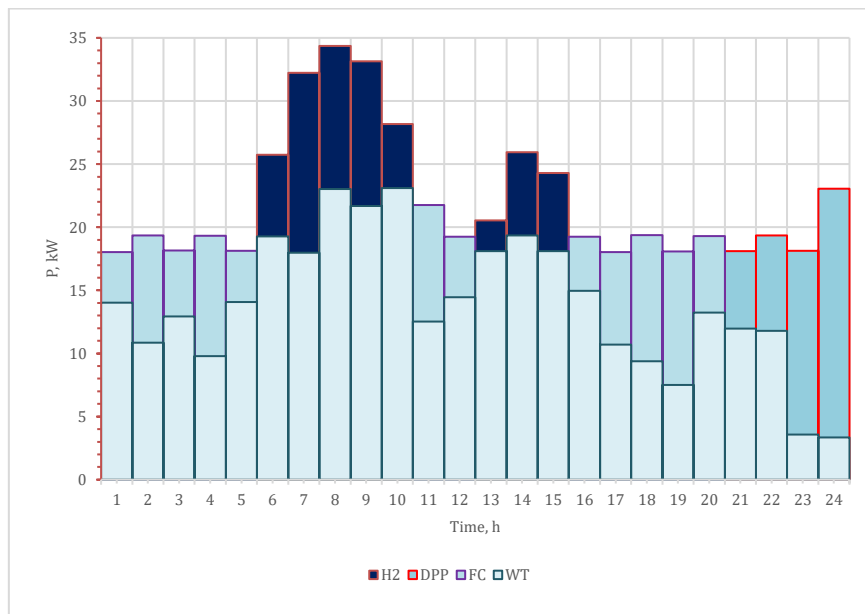

Fig. 6: Dependence of the generated power of the power complex and the load graph of the consumer

Fig. 7 shows a graph of changes in the volume of hydrogen reserves during the year for the considered power complex with a zero supply of hydrogen for the initial moment with unlimited capacity of tanks for its storage. Analyzing this

graph, we can say that by the end of the year, hydrogen reserves are significantly being replenished. This suggests that a sufficiently large hydrogen storage facility will reduce the use of fossil fuels to zero.

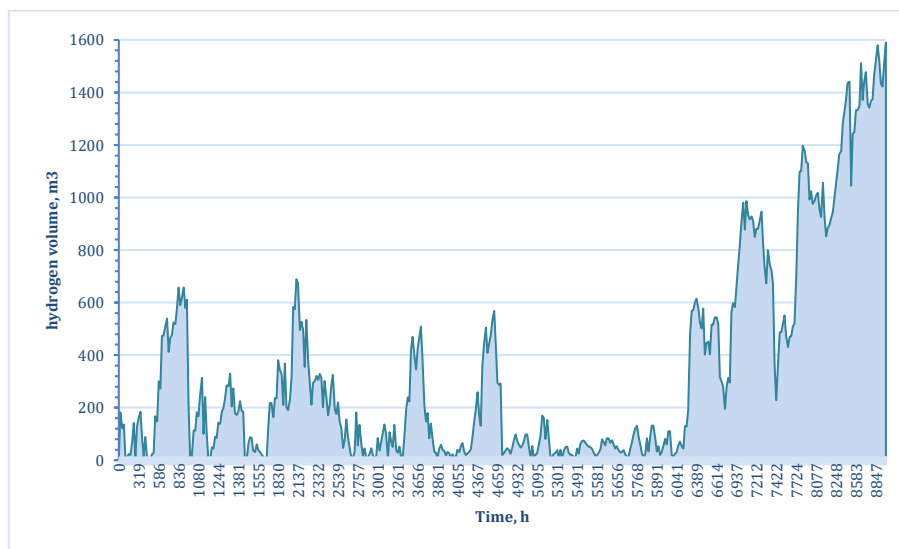

Fig. 7: Change in the volume of hydrogen reserves during the year for the considered power complex with an installed wind turbine capacity of 40 kW

Fig. 8 shows a diagram that displays changes in fossil fuel consumption and the required capacity of the

the hydrogen storage tank depending on the installed capacity of the wind turbine for the year.

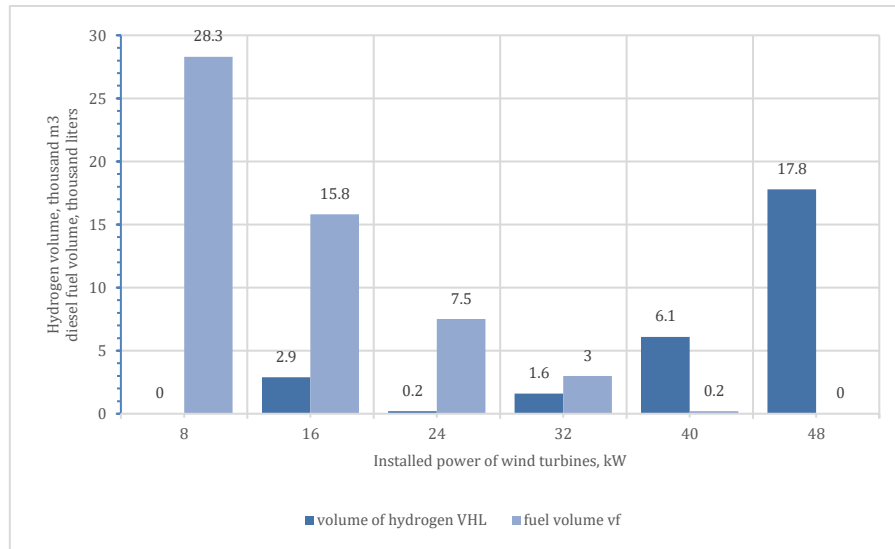

Fig. 8: The volume of used fossil fuel and the capacity of the hydrogen storage tank, depending on the installed power of the wind turbine for the investigated EC

4. Discussions and conclusions

Calculations show that already at present, it is possible to create an energy complex based on wind, heat pumps, diesel installations, and hydrogen storage systems. The project in question showed the economic efficiency of this complex. At the same time, it is possible to refuse the use of DPP. However, for the final decision, this issue requires operational experience. In general, calculations and studies show the high energy efficiency of the complex, and in the presence of the above conditions associated with fuel delivery problems, and its economic efficiency. If we take into account the downward trend in the cost of renewable energy equipment, then we can say that the massive use of such power systems is in question in the next decade.

Acknowledgment

This work was supported by the Deanship of Scientific Research the author: Ahmed Handam, Energy engineering Department, Faculty of Engineering Amman, Arab University Jordan, and the author: Al Smadi T. A. to Jerash University, our thanks to the reviewers for their valuable suggestions to enhance the quality of our article." This work has been carried out during the sabbatical leave granted to the author.

Compliance with ethical standards

Conflict of interest

The author(s) declared no potential conflicts of interest with respect to the research, authorship, and/or publication of this article.

References

- Anagreh Y and Bataineh A (2011). Renewable energy potential assessment in Jordan. *Renewable and Sustainable Energy Reviews*, 15(5): 2232-2239. <https://doi.org/10.1016/j.rser.2011.02.010>
- Arhipova OV (2021). Principles of system analysis for sustainable electric power supply to agro-industrial complexes operating in energy isolated territories. *IOP Conference Series: Earth and Environmental Science*, 723: 052032. <https://doi.org/10.1088/1755-1315/723/5/052032>
- Assi A, Jama M, and Al-Shamisi M (2012). Prediction of global solar radiation in Abu Dhabi. *International Scholarly Research Notices*, 2012: 328237. <https://doi.org/10.5402/2012/328237>
- Duchaud JL, Notton G, Darras C, and Voyant C (2019). Multi-objective particle swarm optimal sizing of a renewable hybrid power plant with storage. *Renewable Energy*, 131: 1156-1167. <https://doi.org/10.1016/j.renene.2018.08.058>
- Elistratov V and Kudryasheva I (2016). Methodology for parameters selection and evaluation the effectiveness of decentralized energy supply systems based on renewable energy sources. *ARNP Journal of Engineering and Applied Sciences*, 11(5): 3509-3512.
- Elistratov V and Kudryasheva I (2019). Regimes, management and economics of energy complexes on the basis of renewable energy sources for autonomous power supply. In the *E3S Web of Conferences: International Scientific and Technical Conference Smart Energy Systems 2019*, EDP Sciences, Kazan, Russia: 124: 04023. <https://doi.org/10.1051/e3sconf/201912404023>
- Elistratov V, Konischev M, and Fedorov M (2017). Optimization of power supply of the circumpolar territories on the basis of renewable energy sources. In the *International Conference on Industrial Engineering, Applications and Manufacturing*, IEEE, St. Petersburg, Russia: 1-5. <https://doi.org/10.1109/ICIEAM.2017.8076220>
- Gil GO, Chowdhury JI, Balta-Ozkan N, Hu Y, Varga L, and Hart P (2021). Optimising renewable energy integration in new housing developments with low carbon technologies. *Renewable Energy*, 169: 527-540. <https://doi.org/10.1016/j.renene.2021.01.059>

- Lo K (2015). Energy efficiency: The definitive guide to the cheapest, cleanest, fastest source of energy. *Energy Technology*, 3(6): 667–667.
<https://doi.org/10.1002/ente.201500099>
- Min TY, Tyagunov MG, and Deriugina GM (2020). Evaluation of the effectiveness of the use of programs in the design of power complexes based on renewable energy resources. In: Kharchenko V and Vasant P (Eds.), *Handbook of research on energy-saving technologies for environmentally-friendly agricultural development*: 28-59. IGI Global, Pennsylvania, USA.
<https://doi.org/10.4018/978-1-5225-9420-8.ch002>
PMid:34138068 PMCID:PMC7770839
- Tronchin L, Manfren M, and Nastasi B (2018). Energy efficiency, demand side management and energy storage technologies–A critical analysis of possible paths of integration in the built environment. *Renewable and Sustainable Energy Reviews*, 95: 341-353. <https://doi.org/10.1016/j.rser.2018.06.060>
- Tyagunov M (2017). Distributed energy system's is the future of the world's power industry. In the 2nd International Conference on the Applications of Information Technology in Developing Renewable Energy Processes and Systems (IT-DREPS), IEEE, Amman, Jordan: 1-4.
<https://doi.org/10.1109/IT-DREPS.2017.8277817>
- Xianguo L (2011). *Green energy: Basic concepts and fundamentals*. Springer, Berlin, Germany.